

Canister Filters

Aqua One®

AQUIS 500 / 700 / 1000 / 1200



Instruction Version 29/07/2019

Instruction Manual

Important Safeguards

This appliance is not intended for use by children or infirm persons without supervision. Young children should be supervised to ensure that they do not play with the appliance.

Warning: To guard against injury, basic safety precautions should be observed, including the following:

1. Read and follow all safety instructions before using this appliance.

2. Danger: To avoid possible electric shocks, special care should be taken since water is employed in the use of aquarium equipment. For each of the following situations do not attempt repairs yourself. Return the appliance to an authorised service facility for service or discard the appliance.

a) If the filter head falls into water, do not reach for it, unplug it and then retrieve it. If the electrical components of the appliance get wet, unplug the appliance immediately (non immersible equipment only).

b) If the filter shows any sign of abnormal water leakage, immediately unplug it from the power source.

c) Carefully examine the filter after installation. It should not be plugged in when there is water on parts which are not intended to be wet.

d) Do not operate any filter if it has a damaged cord or plug, or if it is malfunctioning, or dropped or damaged in any manner.

A "drip loop" (See the diagram) should be arranged by the user for each cord connecting an aquarium component to a receptacle. The drip loop is the part of the cord below the level of the receptacle or the connector if an extension cord used. It is used to prevent water traveling along the cord and coming in contact with the receptacle.

If the plug or receptacle does get wet, do not unplug the appliance. Disconnect the fuse or circuit breaker that supplies the power to the appliance, then unplug and examine for presence of water in the receptacle.

3. Close supervision is necessary when the appliance is used by or near children.

4. Always unplug the filter from the electrical outlet; when not in use, before putting on or taking off parts, before any type of maintenance, or cleaning.

Never yank the cord to pull it from the outlet. Grasp the plug and unplug to disconnect.

5. Do not use the filter for reasons other than the intended use. The use of attachments that are not recommended or sold by the filter manufacturer may cause the product to be unsafe. This is not recommended.

6. Do not install or store the filter where it will be exposed to weather or temperatures below freezing.

7. Make sure any component mounted on a tank is securely installed before operating it.

8. Read and observe all the important notices on the filter.

9. Ensure input voltage is the same voltage as your local power supply.

10. If an extension cord is necessary, a cord with a proper rating should be used. Care should be taken to arrange the cord so that it will not be tripped or pulled.

11. A **G.F.C.I** (Ground fault circuit interrupter) & surge protector is recommended for all electrical appliances.

12. Ensure your hand is dry when turning the power switch on/off and when inserting/removing the power cord from the receptacle.

13. If you are in any doubt about the electrical installation or safety of this product you must consult a qualified electrician.

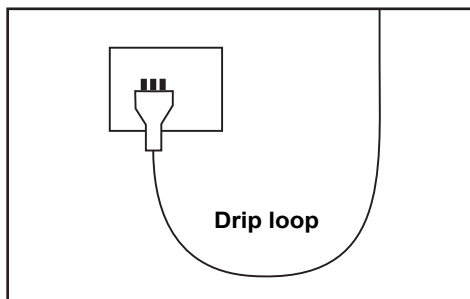

For Guarantee Conditions, please refer to the Guarantee form that is enclosed with this product.

Important Safeguards

Connecting your appliance to the mains electricity supply - Country specific instructions.

United Kingdom

The plug supplied with this product is a sealed plug and we do not recommend removing or changing it. However, should the need arise, only a suitable plug should be connected using the following diagram 1

An approved earth leakage circuit breaker (RCCB) or otherwise known as an Residual circuit current device (RCCD) must be also fitted in the supply line.

IF YOU ARE IN ANY DOUBT ABOUT INSTALLING YOUR APPLIANCE YOU SHOULD CONSULT A QUALIFIED ELECTRICIAN.

Australia, New Zealand and Hong Kong

In Australia, New Zealand and Hong Kong all products are supplied with fitted plugs. This plug should **NOT** be tampered with in any way or removed. Removal or tampering with the plug invalidates our guarantee offered with this product.

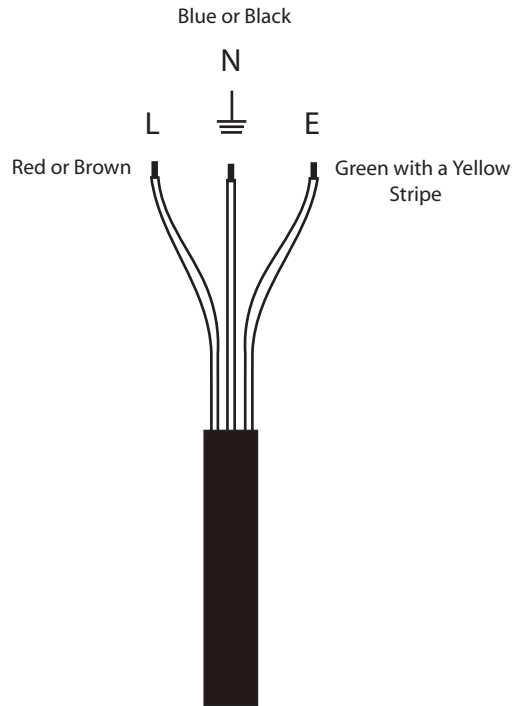

Diagram 1

Before First Use / Preparation

Read and follow all the instructions, even if you feel you are familiar with the product and find a place to keep the instructions handy for future reference. Your attention is drawn particularly to the sections concerning “**IMPORTANT SAFEGUARDS**” and the “**GUARANTEE CONDITIONS**”. Please ensure you retain your original purchase receipt in the event that guarantee service is required.

Carefully unpack the filter making sure you keep all the packing material until all the parts of the product have been found and the product has been assembled.

This product is shipped to you in a factory sealed carton. Should the product malfunction in any way or if the unit is damaged and requires replacement, contact the retailer where the product was purchased for inspection.

Know Your Filter

Aquis 500 / 700 / 1000 / 1200

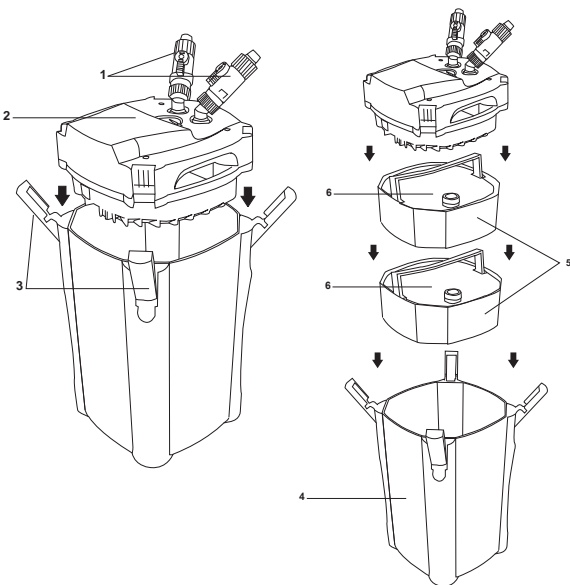

Note: Models 700 and 1200 have 3 media baskets

Replacement Parts & Filter Media

Use Aqua One Genuine Spare Parts Only. See your local Aqua One Dealer and look for the number listed below for the spare part you require. Alternatively you will find these numbers on the silver label located on the product.

500/700 Impeller	37I
1000/1200 Impeller	39I
500/700 Wool Pad	37W
1000/1200 Wool Pad	39W
500/700 15ppi Sponge	37S
1000/1200 15ppi Sponge	39S
500/700 35ppi Sponge	38S
1000/1200 35ppi Sponge	40S

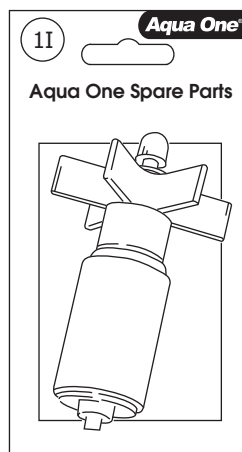

SET UP/PARTS

1. Integrated Tap Connectors
2. Pump Head
3. Clips
4. Canister Body
5. Media Baskets
6. Filter Media

Recommended Filter Media Set Up

Aquis 500

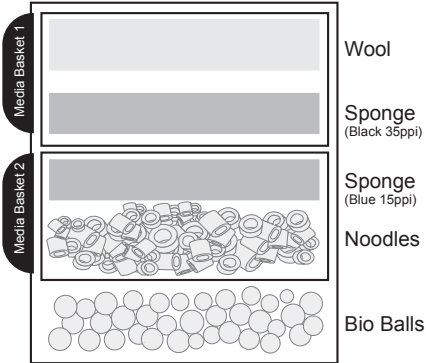

Aquis 1000

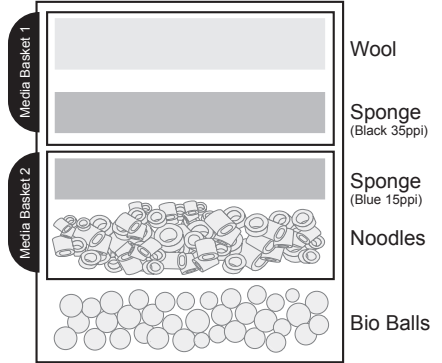

Aquis 700

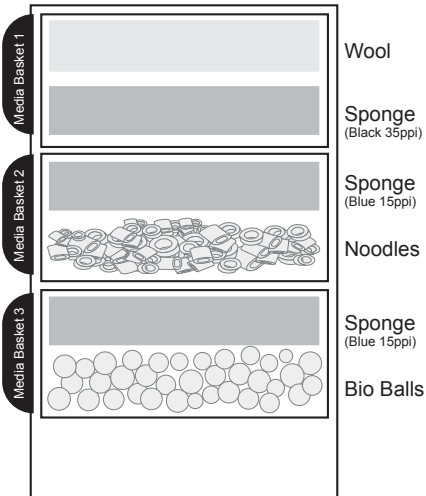

Aquis 1200

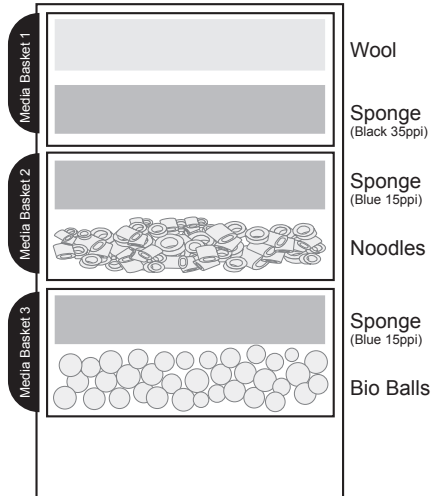

Set Up Instructions

1. Remove the 2 boxed accessory packs and the filter unit from the box.

2. Open the filter unit. To do this release the 4 clips located on the corners of the filter. Fig 1



Fig 1

3. Lift the head unit off the canister body. Place it somewhere safe where it will not be stepped on or broken. Fig 2



Fig 2

4. Take the canister body to the sink. Ensure the area is clean and free from detergents.

5. Remove the filter grid and the filter media baskets from the canister. Fig 3



Fig 3

6. Follow the filter media setup instructions on the previous page which apply to your filter. Remember to remove all media from the plastic bags and rinse in tap water to remove excess dust. The simplest way to do this is empty the correct media into its basket and run tap water through it. Rinse the inside of the canister body in tap water also, remember **DO NOT USE ANY SOAPS OR DETERGENTS**. Fig 4

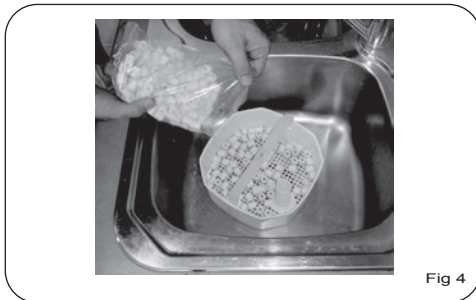

Fig 4

7. Once all the filter media and the canister has been washed and the sponges have been inserted into the filter baskets place the filter media baskets in the correct order (Refer to previous page) back into the canister body. Ensure the filter inlet pipe has the black sealing O-ring at the top of it and that the baskets sit flat on top of each other. The sealing O-ring on the top filter basket is attached to the bottom of the head unit. Fig 5

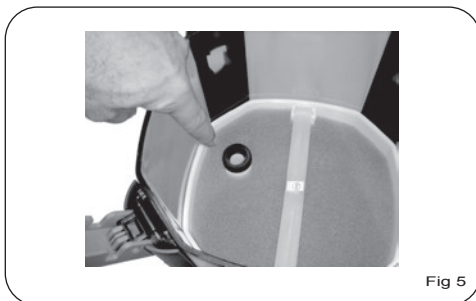

Fig 5

8. Ensure the filter grid is then placed back on top of the last filter basket. This is very important. Fig 6

Installation

1. Open both of the brown accessory boxes and remove all components from there plastic bags. You will find a set of taps and two pieces of hose. Screw the collar on the taps all the way in. (Clockwise) Fig 1



Fig 1

2. Now push one end of the hose over the hose tail and thread. Push it on as far as possible. Fig 2



Fig 2

3. Now turn the collar anti clock wise to lock in the hose. Do this on both pieces of hose.

4. Attach the taps to the inlet and outlet at the top of the filter head. There is a sticker on each tap and a label on the top of the unit which it corresponds to. **IN** goes to **IN** & **OUT** to **OUT**. Fig 3



Fig 3

5. Be sure not to cross thread the tap as this may crack the seat and cause it to leak. Over tightening the tap will have the same effect. **NO TOOLS ARE REQUIRED. HAND TIGHT IS ENOUGH.**

6. Place the canister in the desired position and feed the hose through the cabinet or stand. Fig 4



Fig 4

7. Choose the outlet you wish to use and assemble it. You will find you have 2 Walking Sticks; the shorter one is generally used for the outlet. However if you have a shallow aquarium you can use the longer one.

8. **Outlet option 1** is the Spray Bar, this can be set up to run along the back or side wall of the aquarium.

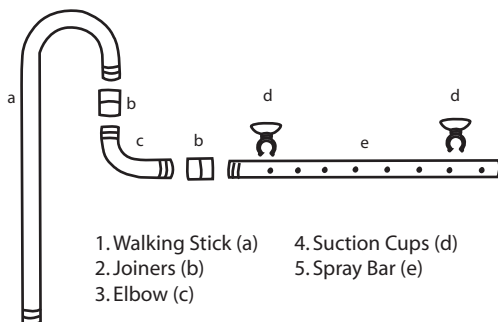

- 1. Walking Stick (a)
- 2. Joiners (b)
- 3. Elbow (c)
- 4. Suction Cups (d)
- 5. Spray Bar (e)

9. Attach a Joiner (b) on to the shorter side of the Walking Stick (a), insert an Elbow (c) into that. Then attach another Joiner (b) onto the other end of the Elbow. (c) Insert the Spray Bar (e) into the other end of the Joiner (b) . Press together firmly. Attach Suction Cups (d) to the Spray Bar.

Installation

10. You can determine how long or short you want the Spray Sar. If you would like it shorter simply use a hack saw to cut it. Be careful not to cut and throw the side away with the end cap in it. DO NOT cut it too short. This will increase back pressure on the impeller and may cause the pump to become noisy!

11. If you would like to extend the Spray Bar simply remove a Joiner (b) from the spare elbow and attach between the two Spray Bars (e). Make certain that the Spray Bar with the end cap in it is installed at the end.

12. **Outlet option 2** is the Duck Bill outlet, this can simply be set up any where along the back wall or side wall of the aquarium.

13. Attach a Joiner (g) into the shorter side of the Walking Stick. (F) Insert a Elbow (h) into the Joiner (g) then attach the Duck Bill (i) onto the other end of the elbow. (h) Press together firmly. Attach the Suction Cups (j) to the Walking Stick. (f) Fig 6

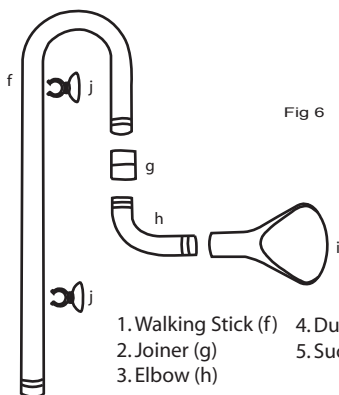

14. Use the second Walking Stick (k) for the Inlet. Simply attach the Strainer (l) to the longer side of the Walking Stick (k). Then Attach two Suction Cups (m). Fig 7

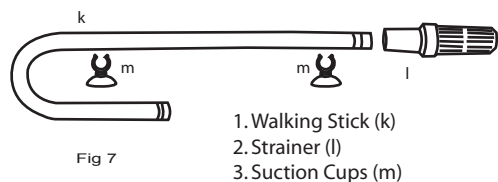

15. You will notice in your accessory boxes an extension for very deep aquariums. Attach the extension onto the bottom of the Walking Stick (k) then the Strainer (l) onto the bottom of the extension.

16. Install the inlet first. (One with the Strainer (l) Place it into the aquarium, stick it to the glass wall. Fig 8



17. Pull the hose from the inlet side of the filter up next to the inlet Walking Stick and line up.

18. Measure a good 10cm more that what you need past the bottom of the Walking Stick. Fig 9

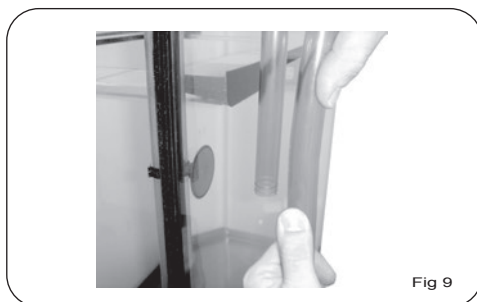

19. Cut the hose using a sharp blade, try to cut it straight and be careful not to cut yourself.

20. Force the hose onto the Walking Stick. You should be able to get it on 2.5 to 3cm. Fig 10

Installation



Fig 10

21. Repeat steps 19 to 22 for the outlet.

22. Place the suction caps on the spray bar or duck bill then attach it to the back or side of the aquarium. Fig 11



Fig 11

23. You are now ready to start your filter.

Starting Your Filter

METHOD 1

NOTE: Your aquarium must be filled with water to prime your filter. Ensure both taps are in the on position by shifting the plastic lever from the **OFF** (Horizontal position) to the **ON** (Vertical position). **NOTE:** Once the filter is running, double check the fittings and seals for water tightness. Fig 1

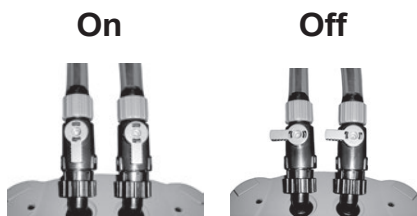

Fig 1

1. Temporarily detach the outlet from the tubing. Either the Spray Bar or the Duck Bill. Fig 2



Fig 2

2. Place your mouth over the end of the outlet and create siphon effect by sucking on the tube. Fig 3



Fig 3

3. Once the siphon begins, lower the outlet tube into a bucket. Fig 4



Fig 4

4. Now wait until the siphon continues to fill the canister and eventually overflow into the bucket via the outlet pipe.

5. The filter is primed when the intake pipe and filter is completely filled with water.

Starting Your Filter

6. Now place your thumb over the open end of the tubing or turn the taps to the off position.

7. Reattach hose to the outlet pipe and affix the outlet pipe to your aquarium.

8. Turn the taps back to the **ON** position.

9. Now the Canister Filter is ready to be plugged in. Fig 5

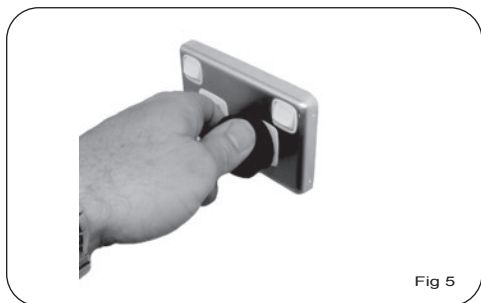

METHOD 2

1. Carefully remove the priming cap on the top of the head unit by gently pushing the red safety button outward and rotating the priming cap until it comes off. Fig 6

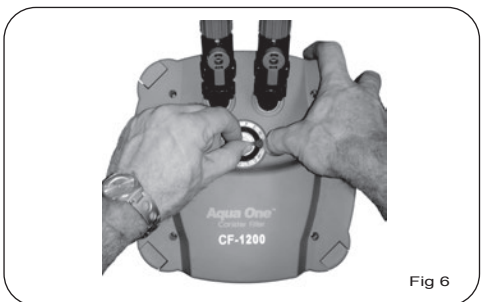

2. Fill the pump lid housing to the brim and replace the priming cap. Fig 7



3. Make sure that the priming cap locks firmly back into the red safety button. Fig 8

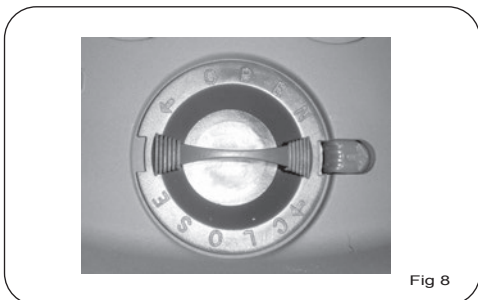

4. Now the Canister Filter is ready to be plugged in.

Cleaning your filter

1. Turn the canister filter off at the socket and unplug.

2. Turn both of the taps to the off position. Fig 1

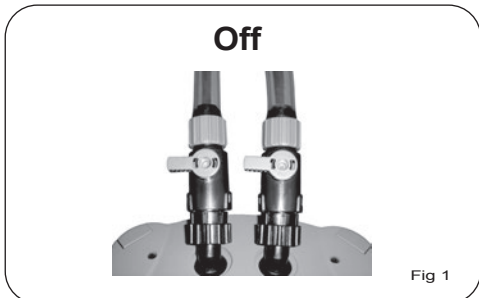

3. Place a towel or a shallow container under the canister unit. This will prevent any water spilling onto your cabinet or stand and damaging it.

4. Disconnect the taps from the head unit by unscrewing them. Undo the collar closest to the head of the filter. Not the ones on the same side as the hose. Please note some water will leak out. Fig 2



5. Fill a bucket with water from your aquarium and take it to the sink or wherever you intend to clean your filter. Keep in mind cleaning your filter can be messy, cleaning is recommended outside or at a sink. Ensure the area is clean and free from soaps and detergents.

6. Open the canister. Release the 4 clips and remove the head unit, place it somewhere safe where it will not be trodden on or broken.

7. Remove the filter grid, extend the handles on the media baskets and remove them from the canister body. Fig 3



8. Remove the filter sponges and the white wool from the media baskets and dunk the baskets with the bioballs and ceramic noodles (Or any other type of biological media which may be in them) several times into the bucket. This will clear some of the dirt that can build up and clog the media and prevent the good bacteria which aid in breaking down pollutants in your aquarium from being killed by the chlorine in tap water.

9. Either replace or rinse the white wool pad using a high pressure hose. It should be replaced regularly or when it begins to deteriorate and can no longer be cleaned properly.

10. The sponges can also be rinsed in the bucket of aquarium water (Providing the water is not dirty. Replace if necessary) they will also require replacement eventually as over time they clog and prevent water from traveling through them easily.

11. Empty the bucket of aquarium water into the canister body. (Avoid tipping any dirt which may have settled on the bottom of the bucket into the canister)

12. If you have a Aquis 500 or 1000 your bioballs are located here. Simply swirl the filter around to loosen and dirt on the bioballs off and then empty the canister body ensuring the bioballs do not fall out.

13. Place the sponges back into their respective positions and reinsert the media baskets back into the canister body ensuring that each media basket sits nicely on top of the other.

Cleaning your filter

14. The impeller should also be cleaned when ever the filter is disassembled.

15. Turn the head unit over and turn the impeller locking cover anti clock wise and remove it. Fig 4

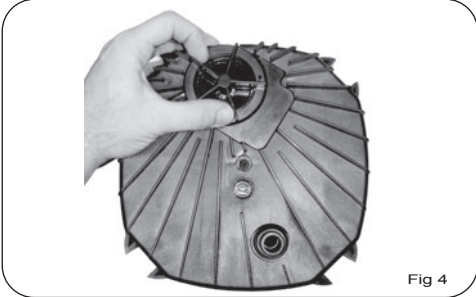

16. Then pull the impeller cap off and remove the impeller. Fig 5

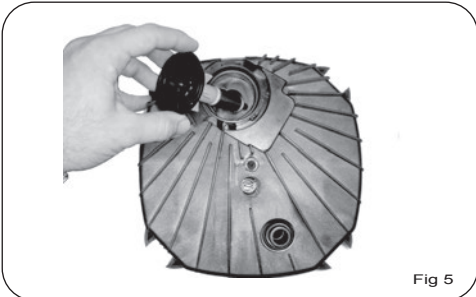

17. Clean the impeller well and the outlet channel using a double ended pipe brush. Fig 6

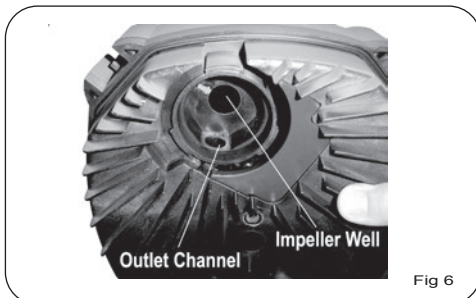

18. Use the double ended pipe brush and clean the inlet tube which runs through the base of the head unit. Fig 7



19. Pull the rubber end cap off the shaft of the impeller and run water through the hole in the middle of the impeller. Clean any debris which may have built up on the shaft off, along with any slime build up on the impeller. Fig 8

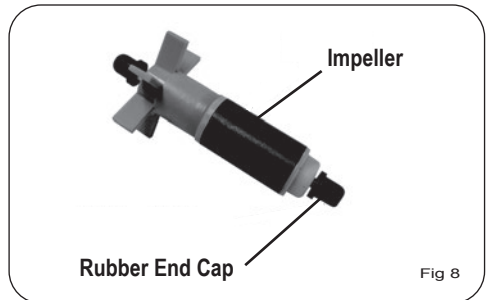

20. Put the impeller back together and ensure that it rotates freely on the shaft. Then reassemble the head unit, ensure there is no water on the power cord, plug the head unit in and turn on. Make certain the impeller is spinning. Turn it off. Reassemble the filter unit. Apply an aquarium safe lubricant to the O-ring on the head unit. This will provide a better water seal and make the removal of the head easier next time the filter has to be disassembled for maintenance. Fig 9

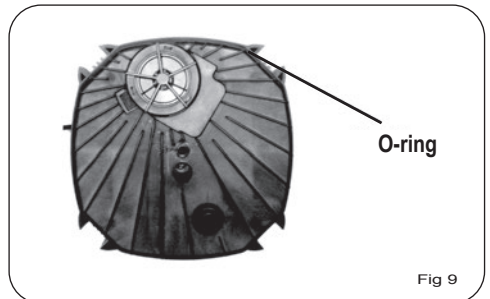

Cleaning your filter

21. Check your inlet, outlet tubes and hoses. If residue has built up on the inside of them remove them from the aquarium. Take to the sink, run hot water through them to loosen the slime. Run a double ended pipe brush through them, and flush again with hot water. This build up will reduce the flow rate of your filter considerably, so clean when ever it is possible.

22. Return the canister filter to your cabinet or stand and reattach the taps.

23. Refer to the section in this instruction manual Starting You Filter for details on restarting the unit.

Trouble Shooting

THE FILTER UNIT IS LEAKING

1. Check all O-rings are in place and that they are not damaged or soiled.
2. Re-apply tank safe silicon lubricant.
3. The media baskets may not aligned properly.
4. The inlet pipe on the pump head is not aligned with the media basket flow through pipe.

THE FILTER WILL NOT PRIME

1. Check tubing for kinks.
2. Make sure both taps are in the on position (*vertical*).
3. The aquarium needs to be filled.
4. Make sure the intake tube and/or intake strainer is not blocked.
5. Ensure the hoses are connected to the unit correctly. **IN** to **IN** and **OUT** to **OUT**.

THE FILTER WILL NOT START

1. As the previous tips.
2. Check the impeller and shaft are in good condition.
3. Verify the filter is plugged in.

LOW WATER FLOW

1. As both previous tips.
2. Clean the filter media.
3. Clean the intake and outlet pipes.
4. Clean all tubing.

BOTH WATER & AIR COMING FROM OUTLET PIPE

1. Leave 3-5 minutes.
2. Make sure an air stone is not operating near the intake strainer.
3. Check all tubing is connected firmly.
4. Check all O-rings and re-apply tank safe silicon lubricant.
5. Gently rock filter back and forth trying to discharge the air in the canister.

FILTER IS MAKING NOISE

1. As per previous tips.
2. Outlet or inlet flow is restricted.



Specifications

Canister Model: AQUIS 500
Number of Media Baskets: 2
Dimensions: 18.5 x 27 x 18.5cm
Max Aquarium Volume: Up to 100L
Operating Flow Rate*: 350L\hr
Maximum Flow Rate:** 500L\hr
Max Head Height: 1.5M
Filter Volume: 5 Litres
Power Requirements: 220 ~ 240V
Power Consumption: 15W
Suitable: Coldwater, Tropical, Marine

Canister Model: AQUIS 700
Number of Media Baskets: 3
Dimensions: 18.5 x 33 x 18.5cm
Max Aquarium Volume: Up to 150L
Operating Flow Rate*: 400L\hr
Maximum Flow Rate:** 600L\hr
Max Head Height: 1.7M
Filter Volume: 6.5 Litres
Power Requirements: 220 ~ 240V
Power Consumption: 20W
Suitable: Coldwater, Tropical, Marine

Canister Model: AQUIS 1000
Number of Media Baskets: 2
Dimensions: 22 x 32 x 22cm
Max Aquarium Volume: Up to 200L
Operating Flow Rate*: 700L\hr
Maximum Flow Rate:** 1000L\hr
Max Head Height: 1.8M
Filter Volume: 8.5 Litres
Power Requirements: 220 ~ 240V
Power Consumption: 30W
Suitable: Coldwater, Tropical, Marine

Canister Model: AQUIS 1200
Number of Media Baskets: 3
Dimensions: 22 x 40 x 22cm
Max Aquarium Volume: Up to 250L
Operating Flow Rate*: 750L\hr
Maximum Flow Rate:** 1100L\hr
Max Head Height: 2M
Filter Volume: 12 Litres
Power Requirements: 220 ~ 240V
Power Consumption: 35W
Suitable: Coldwater, Tropical, Marine

* Operating flow rates are based on a typical set-up with the canister filter placed under the aquarium, in a cabinet complete with filter media, pumping to a total height of 120cm, not including spray bar or duck bill attachment.

** Maximum flow rates are based on measurements taken as the water exits the filter unit when it is positioned next to the aquarium with no filter media in the canister.

Aqua One 3 Year Guarantee



CUSTOMER CARE

Thank you for choosing this Aqua One product.

Your Aqua One product is covered for parts and labour for 3 years from the date of purchase as detailed in the terms of the Guarantee below. For any inquiries or concerns regarding this product or any of our products, please do not hesitate to contact your local Aqua One Retailer or visit Aqua One Customer Care online in your country of purchase via the websites listed.

Australia:
www.aquaone.com.au
New Zealand:
www.aquaone.co.nz
United Kingdom:
www.aquaone.co.uk
All other countries:
www.aquaone.com.au

Australian Consumer Law.

In Australia the Aqua One guarantee applies in addition to the guarantees that can not be excluded under the Australian Consumer Law. You are entitled to a replacement or refund for a major failure and for compensation for any other reasonably foreseeable loss or damage. You are also entitled to have the goods repaired or replaced if the goods fail to be of acceptable quality and the failure does not amount to a major failure.

About this Guarantee

The Manufacturer or Distributor, of Aqua One goods, is collectively known herein as "Aqua One". Please refer to contact details for Aqua One below or on the applicable Aqua One website. Any product that is covered by its own guarantee (as enclosed with the product) is subject to the conditions of that guarantee.

The benefits given to the purchaser, under guarantee, are in addition to all other statutory rights and remedies which the purchaser has in respect of products under legislation in the applicable country of purchase. This guarantee shall not affect any such rights and should be read subject to such legislation.

Terms and conditions of your Aqua One Guarantee

1. The Aqua One guarantee becomes effective from the date of purchase.
2. You must provide the proof of purchase before any repair or replacement of your Aqua one product is considered when requesting a guarantee claim.
3. All products subject to guarantee claim should be prepared for transportation in the original packaging or other comparable packaging which offers the same degree of protection.
4. Where products are repaired or replaced under guarantee, these products are guaranteed for the remainder of the original guarantee period, where permitted by local law.
5. Where claims on inspection reveal goods are in normal working order, Aqua One will request reimbursement of all reasonable costs incurred.
6. Where Aqua One determines the products are being used in a manner contrary to the intended purpose/use, instructions, specifications or this guarantee, Aqua One reserves the right to terminate the guarantee and will provide written notice to the purchaser.

What is covered:

1. Aqua One warrants to the purchaser, for 3 Years from date of original purchase, to repair or replace products where fault is found due to defective materials or faulty workmanship and where goods do not operate in accordance with the instructions.
2. The guarantee covers any other products as enclosed with the product unless those products are provided with their own guarantee.

What is not covered

Where permitted by local law, the following exclusions and limitations apply in regard to guarantee:

1. Product guarantee claims where fault is due to, but not limited by a) misuse b) neglect c) abuse d) fire or flood e) normal wear and tear f) accidental breakage g) Acts of God h) mains voltage fluctuation or supply problems i) connection to any voltage other than what is stated on the rating plate j) modification or tampering to electrical cord or plug, k) vermin, insects or foreign objects l) liquid spillage or submersion of goods not designed to sustain such use or duress.
2. Where inspections reveal the products are in normal working order including where noise or vibration is consistent with normal product operation.
3. Where the product's factory rating plate has been removed, altered, damaged or is rendered illegible.
4. Where products are not installed, operated or maintained in accordance with Aqua One's product instructions, specifications or this guarantee.
5. Replacement or repair of worn consumables such as: Impellers/Shafts, Filter Media & O-rings.
6. Replacement of lost products, parts or components.
7. Costs associated with products transportation, removal, installation, postage or cost of insurance.
8. Any damage incurred whilst installing, transporting or moving the goods.
9. Subject to certain local statutory rights and obligations to the contrary, and this guarantee shall not affect those rights or obligations, where, to the full extent permitted by law: 1. all express and implied warranties and conditions under statute or general law, are expressly excluded and Aqua One, where permitted, will limit liability as follows and at Aqua One's option to: in regard to products either a) the replacement of goods or supply of equivalent goods b) the repair of products or the cost of replacing the products OR of acquiring equivalent products OR in regard to services either c) the re-supply of services d) the cost to re-supply services. 2. Aqua One will not be liable for any loss or damage, including consequential loss or damage either directly or indirectly, or for any incidental expenses, of any kind, and in any way whatsoever

Australia
Kong's (Aust.) Pty. Limited
PO Box 863, Ingleburn
1890 NSW Australia
www.aquaone.com.au

Hong Kong
Kong's Aquarium Supplies Co., Ltd
No 31, 3/F Thriving Industrial Centre
26-38 Sha Tsui Road, Tsuen Wan,
Hong Kong
www.aquaone.co.hk

New Zealand
Kong's (NZ) Limited
PO Box 15 - 183, Tauranga
3015 New Zealand
www.aquaone.co.nz

United Kingdom
Kong's (UK) Limited,
C/O Aqua Pacific UK Ltd.
PO Box 268
Romsey Hampshire, SO51 0WW
United Kingdom
www.aquaone.co.uk